

Frese STBV Range

VODRV · DN15 - DN50

- DK** Montagevejledning
- DE** Montageanleitung
- EN** Mounting instructions

Denmark Main Office Tel. +45 58 56 00 00

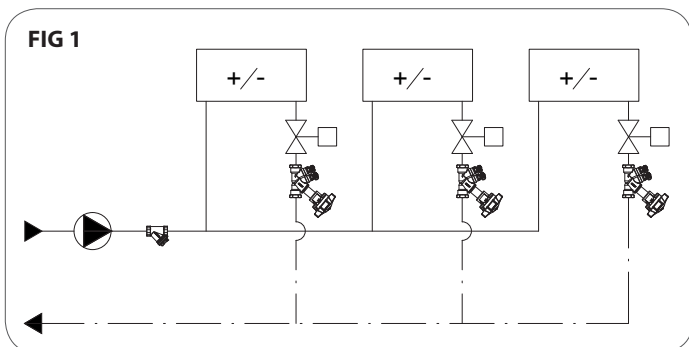

DK **FIG 1:** Frese STBV VODRV kan monteres i såvel frem- som returløb. Det anbefales at montere snavssamler og afspærringer.

DE **FIG 1:** Frese STBV VODRV kann sowohl im Vor- als auch im Rücklauf montiert werden. Es empfiehlt sich, Schmutzfängersieb und Absperrkugelhähne zu montieren.

EN **FIG 1:** Frese STBV VODRV can be installed in either the supply line or the return line. The use of strainers and isolation ball valves is recommendable.

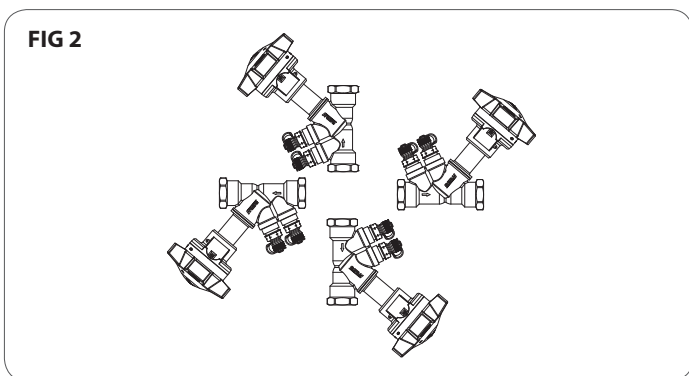

DK **FIG 2:** Ventilen kan positioneres frit i rørsystemet.

DE **FIG 2:** Das Regelventil kann beim Einbau ins Rohrsystem in jeder Lage montiert werden.

EN **FIG 2:** The valve can be installed in every position.

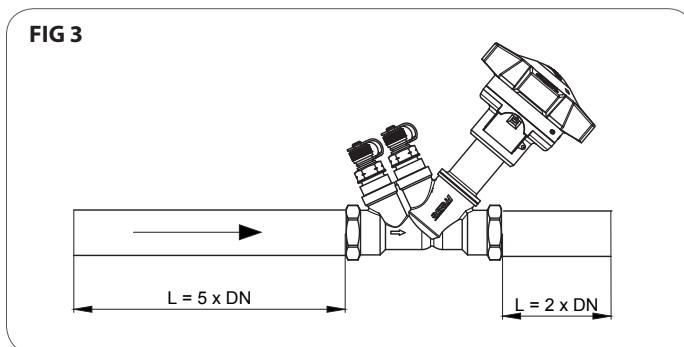

DK **FIG 3:** For at opnå en tilfredstillende verificering af flow skal reguleringsventilen installeres med en lige rørlængde på minimum 5 x rørdiameter før ventilen og 2 x rørdiameter efter ventilen.

DE **FIG 3:** Um einen zufriedenstellenden Messung der Volumenstrom zu erhalten, muss das Ventil mit einer Mindestlänge von gerade Rohr bis 5 x Rohrdurchmesser vor dem Ventil und 2 x Rohrdurchmesser nach dem Ventil installiert werden.

EN **FIG 3:** In order to obtain a satisfactory verification of the flow, the valve must be installed with a minimum length of straight pipe at 5 x pipe diameter upstream of the valve and 2 x pipe diameter after the valve.

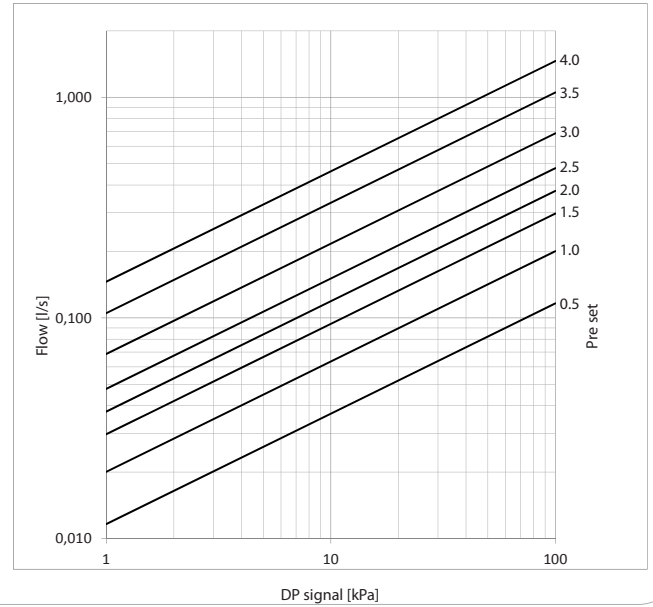
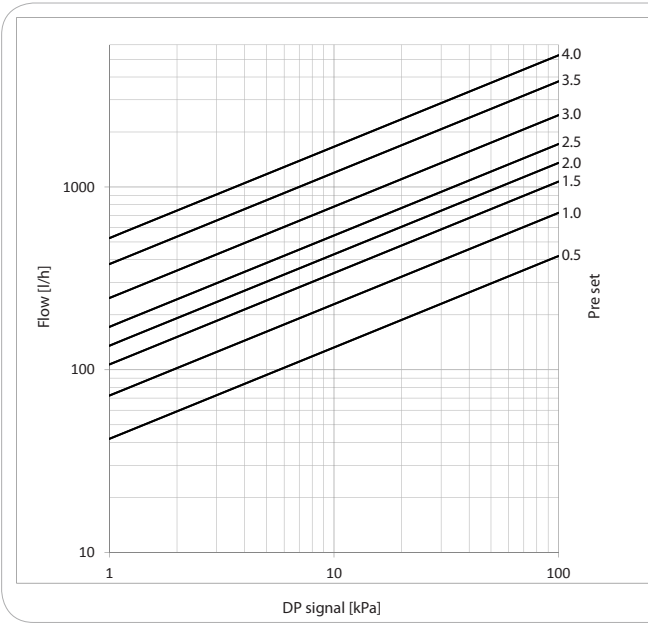

DN15

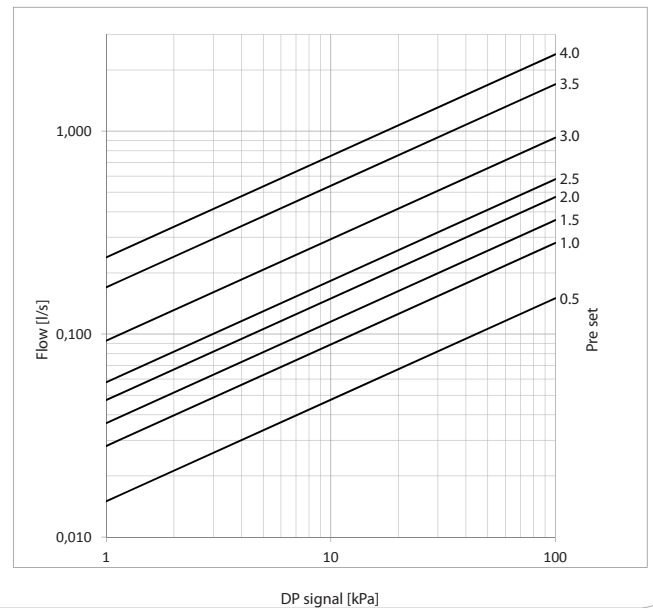
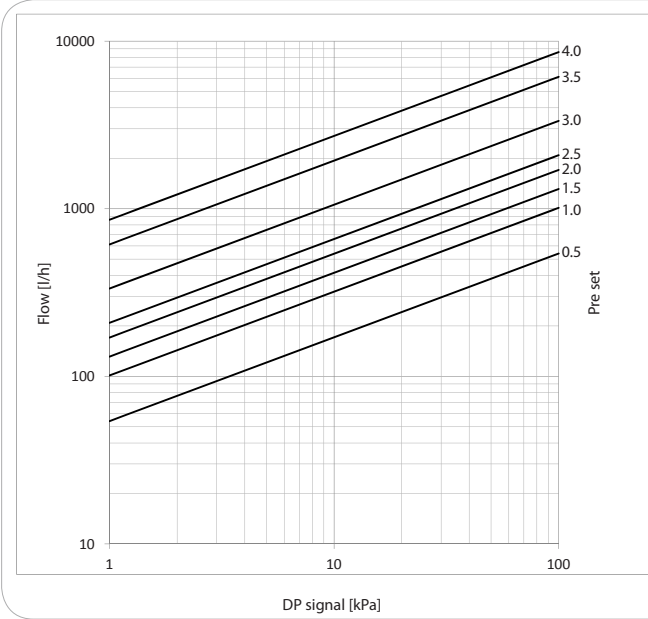

DN20

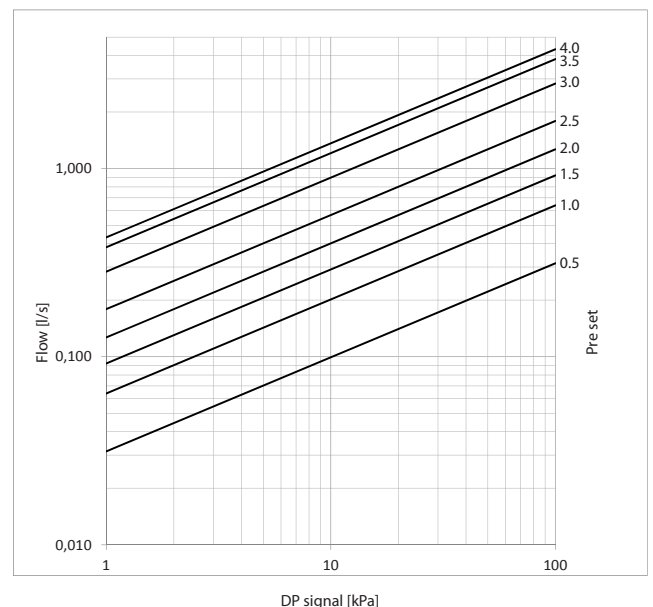
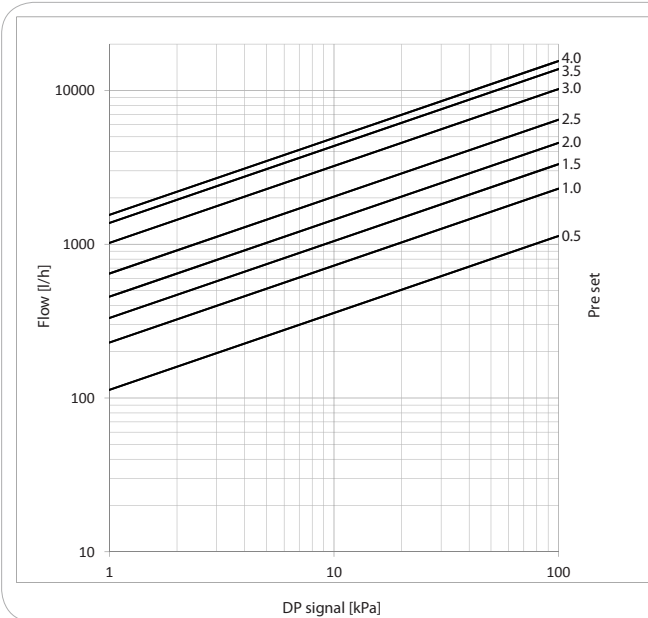

DN25

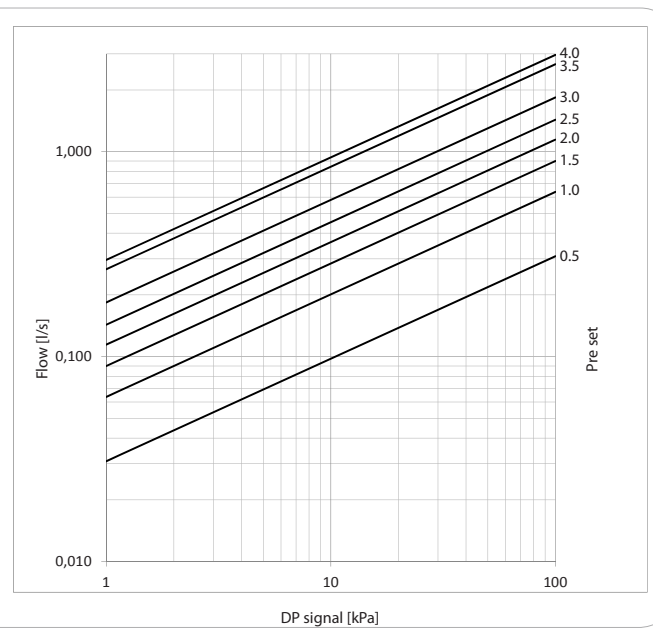
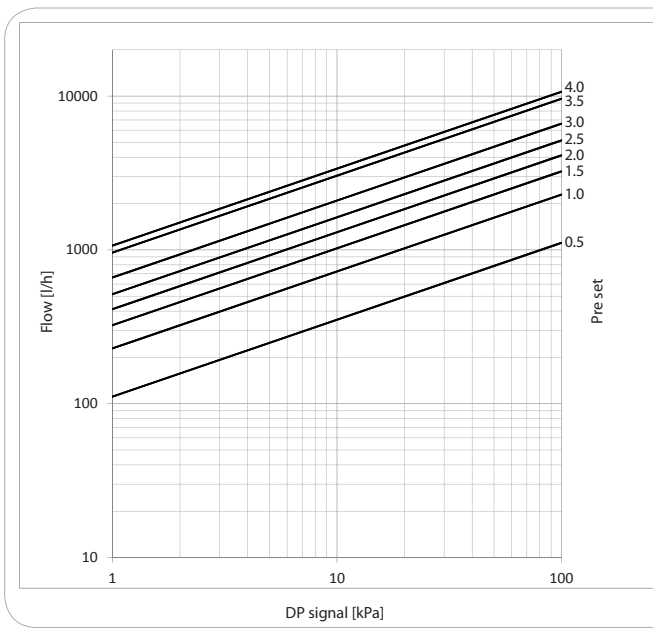

DN32

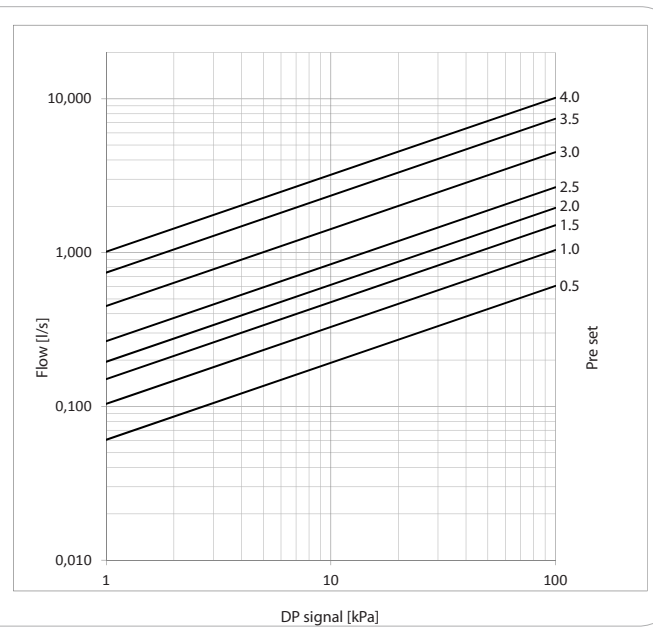
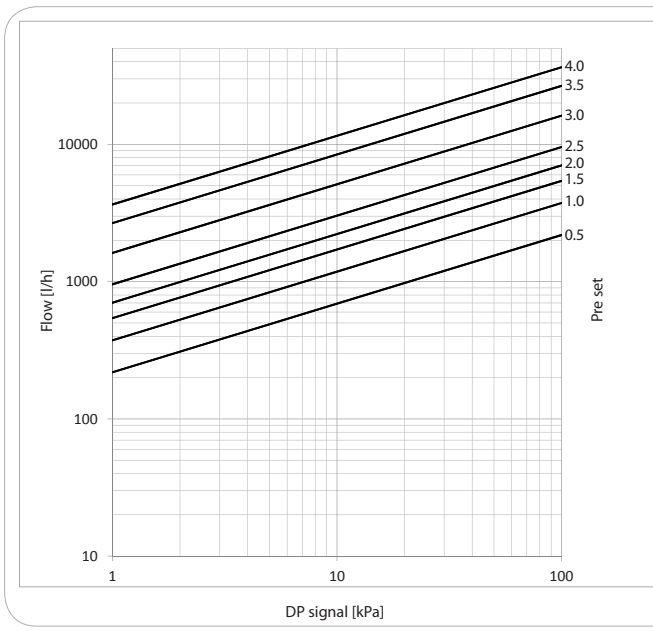

DN40

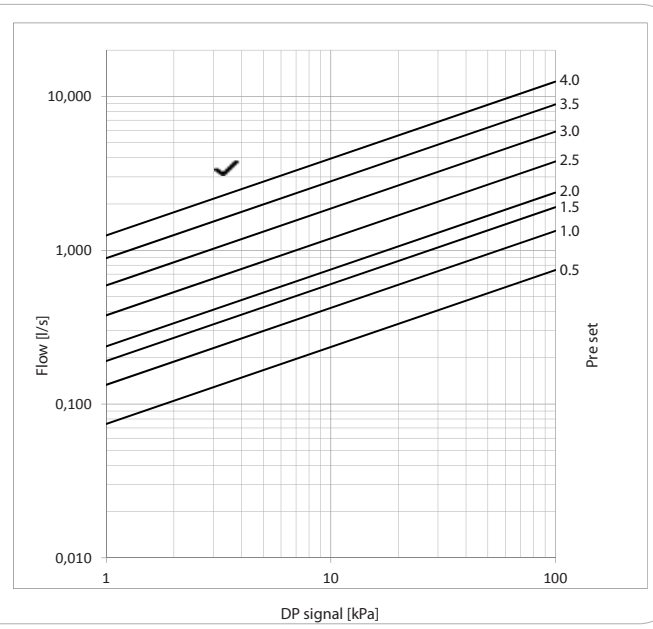
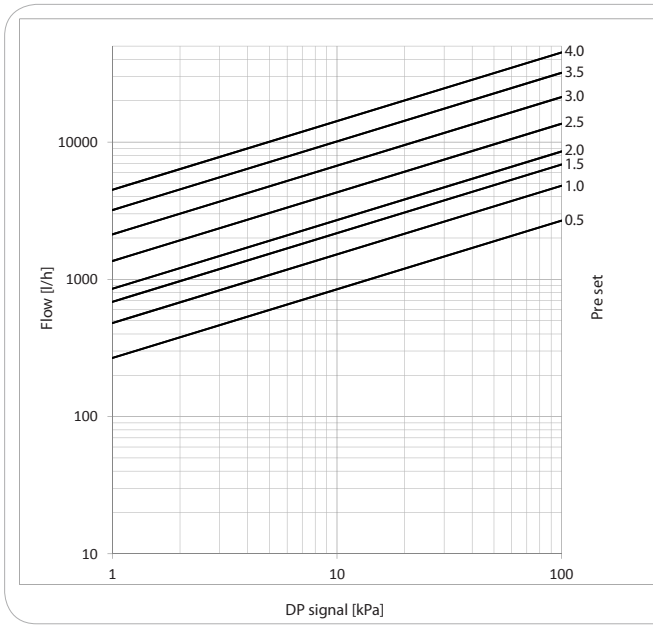

DN50